

SK	Function
0	Mains switch
1	Input selector left (track 1)
101	Input selector, right (track 2)
2	Recording track selector (1)
102	Recording track selector (2)
3+103	Speed selector switch
4+104	A-her - B-before switch
5	Monitor track selector 1
105	Monitor track selector 2
6+106	Vu meter
7	Voltage selector
8	Remote control
9	Pause button
10	Automatic stop
11	Start contact (RE1)
12	Start contact
13	Delay contact for start (playback)
14	Delay contact for auto-stop (RE6)
15	Playback switch
16	Recording switch
17	Fast rewind, switch
18	Fast wind, switch

Re-Nr.	Electrical	Mechanical
1	SK11	
2	SK12	
3		Tape-end switch
4		Brakes
5		
6	SK14	Pressure roller

SK5	SK4-SK104	SK105
Closed contacts		
Released	MON. out-put 1 Stereo + SK5	MON. out-put 2 Stereo + SK5
1-3	1-3	1-3
3-2	2-3	3-2
5-6	6-4	5-6
	1-3	6-4

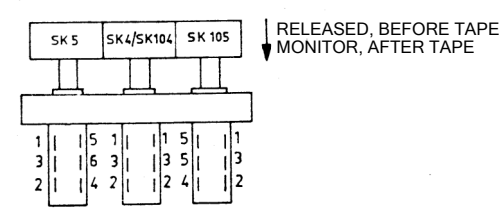

SK3/SK103	
Closed contacts	
9.5 cm/s	19 cm/s
28-26	24-26
30-32	30-32
38-26	38-34
46-42	46-44
2-4	2-6
25-27	25-23
	31-29
	37-33
	45-43
	1-3
	1-5

SK1			
Closed contacts			
Line	Microph.	Diode	Multi-play
2-10	4-10	6-10	8-10
7-11	9-11	3-11	5-11

SK101			
Closed contacts			
Line	Microph.	Diode	Multi-play
1-9	3-9	5-9	7-9
8-12	10-12	2-12	4-12

SK6/SK106	
Closed contacts	
10 dB	Normal
1-3	5-3
2-4	6-4

SK9	
Closed cont.	
Operation	Pause
1-2	

SK15	SK16	SK17	SK18
Closed contacts			
Play-back	Stop wind-rev.	Recording	Playback wind-rev.
3-5	1-3	3-5	1-3
4-6	2-4	4-6	4-6
9-11	7-9	9-11	2-4
10-12	10-12		15-17
16-18	17-15		16-18
			13-15
			3-5
			13-15
			4-6
			14-16
			15-17
			16-18

SK10	
Closed cont.	
Winding rewinding	Stop
1-2	

SK13	
Closed contacts	
Playback	Stop wind, rev.
1-2	

SK14	
Closed contacts	
Playback	Stop wind, rev.
3-2	1-2

SK102	SK2
Closed contacts	
Released mixing 1	2
1-3	3-5
7-9	9-11
13-15	15-17
2-4	21-23
8-10	10-12
	16-18
	22-24
	1-3
	7-9
	15-17
	13-15
	21-23
	4-6
	2-4
	8-10
	16-18
	22-24

SK102	SK2
Released RECORDING STEREO	
1	1
2	2
3	3
4	4
5	5
6	6
7	7
8	8
9	9
10	10
11	11
12	12
13	13
14	14
15	15
16	16
17	17
18	18
19	19
20	20
21	21
22	22
23	23

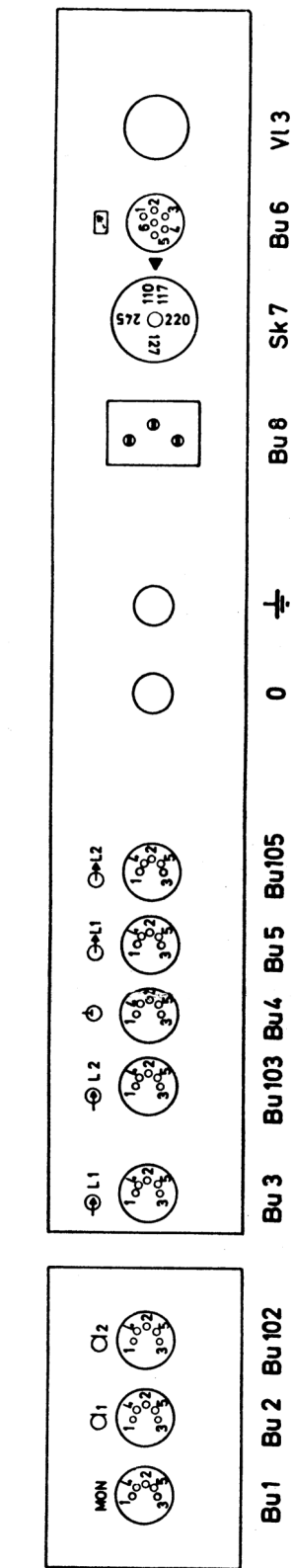
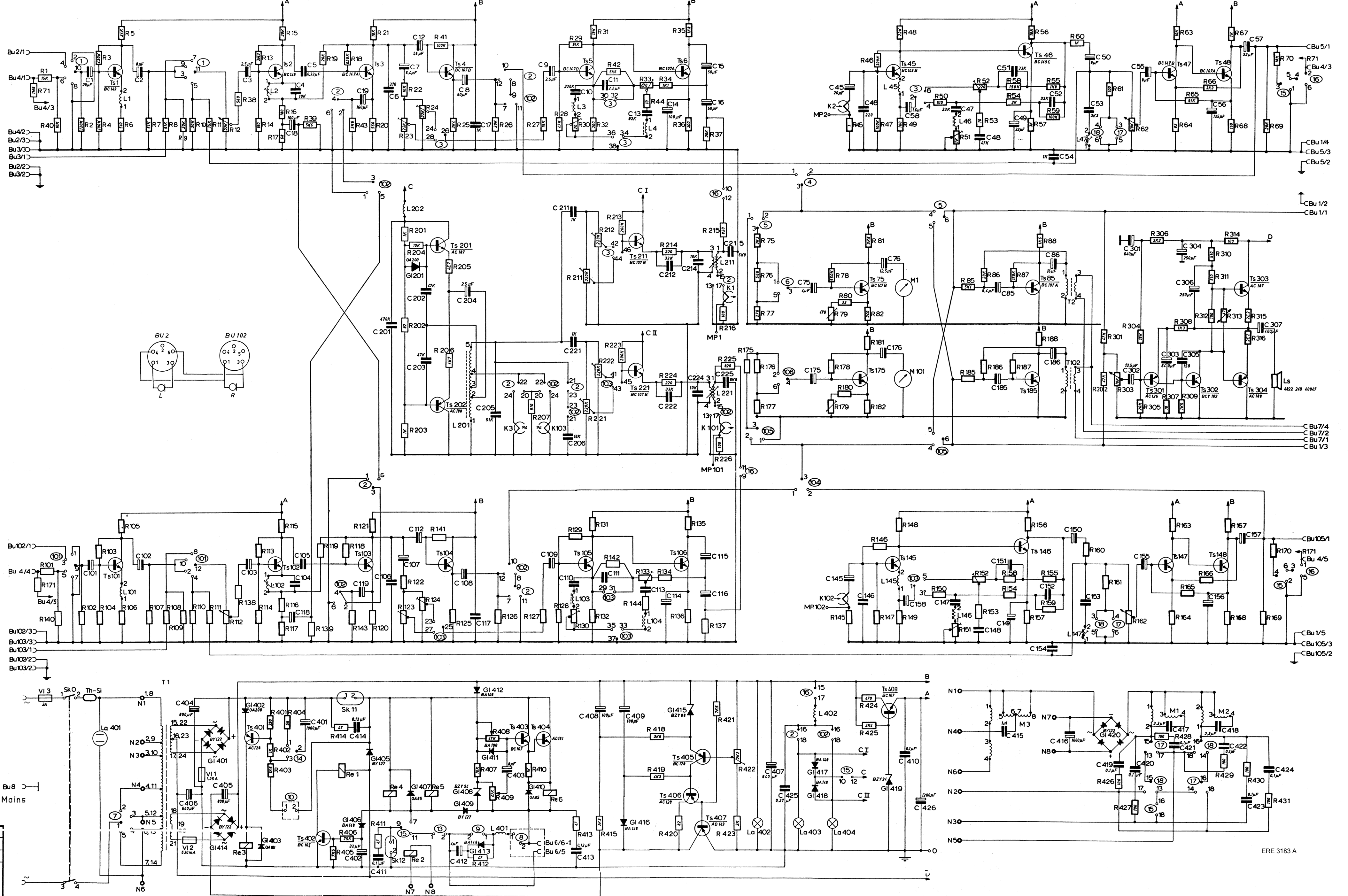
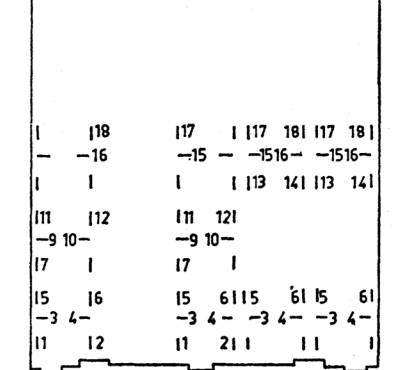
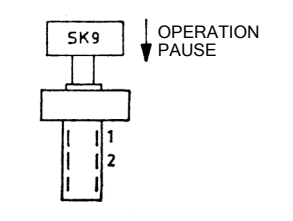
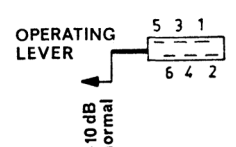
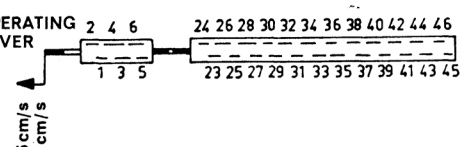
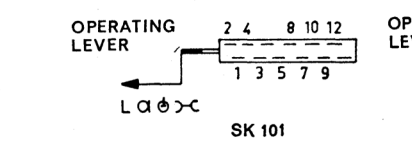
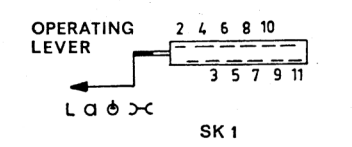

ERE 3183 A